

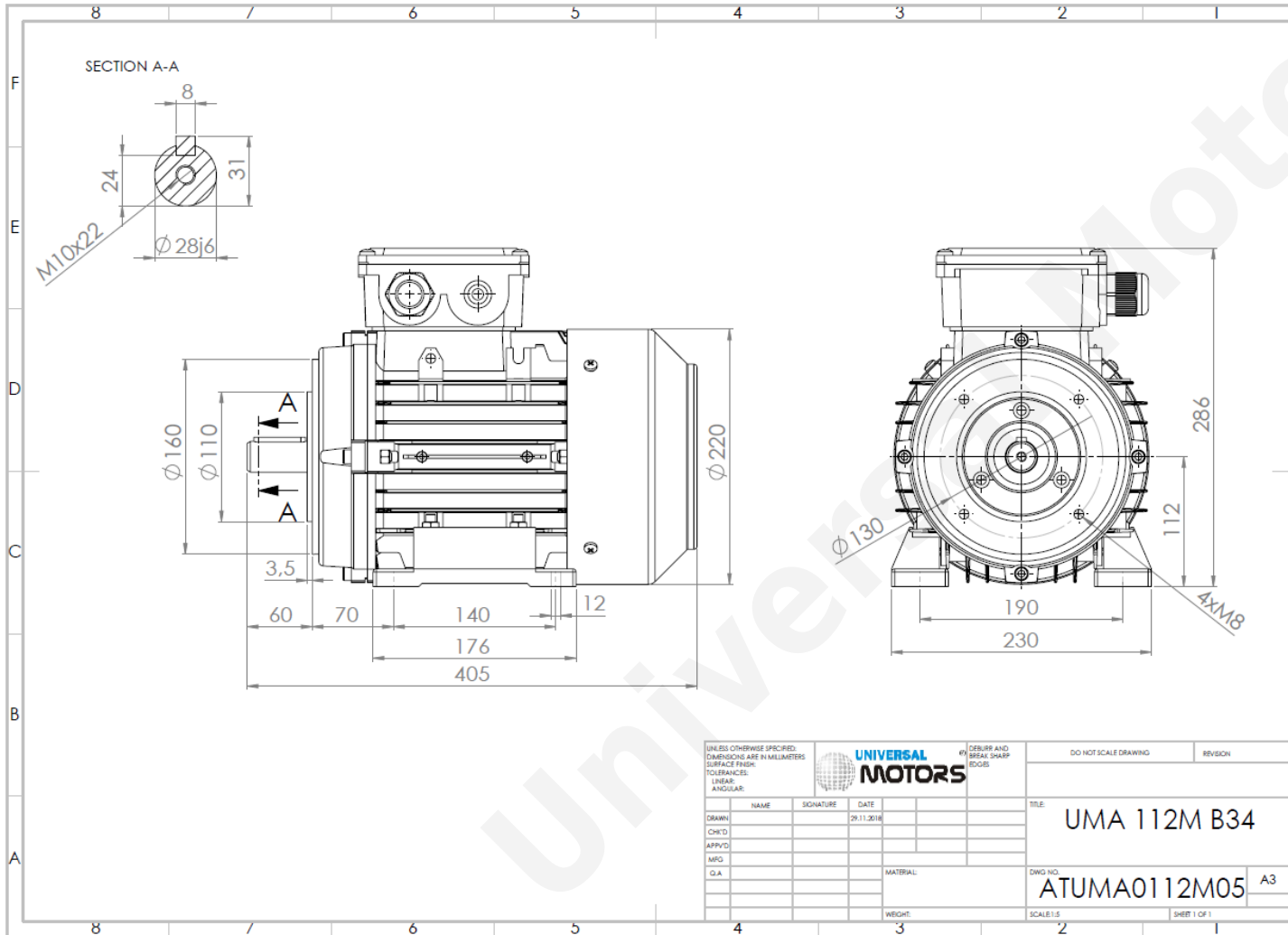

TECHNICAL DATA

Three Phase Electric Motors - Aluminum Frame
 UM2A 112M1-6
 2.2 kW / 3 Cv
 955 RPM



Motor type:	UM2A 112M1-6
Output:	2.2 kW / 3 Cv
Speed (min ⁻¹):	955 RPM
Frequency:	50 Hz
Voltage:	400 V
Current:	5.32 A
Power factor (Cos Ø):	0.73
Poles:	6
Insulation class:	F
Temperature rise Class:	B
Efficiency 50%:	81.8 %
Efficiency 75%:	82.9 %
Efficiency 100%:	81.8 %
Torque:	22.0 N.m
Tstarting/Tnominal:	2.1
Istarting/Inominal:	5.5
Tmaximum/Tnominal:	2.7
Noise:	64 Db(A)
Weight:	26.0 Kg
Brake AC:	AC6
Torque Brake DC:	60 N.m
Bearing DE:	6306 2Z
Bearing NDE:	6206 2Z
Torque Brake AC:	60 N.m
Brake DC:	REB-05-14

Regime - S1

Altitude - 1000m

Environment Temperature - 40°C

CONTACTS:

UNIVERSAL MOTORS Tel: +351 252 299 080
 Rua de São Brás,745 Fax: +351 252 299 089
 4480-782 VILA DO CONDE Mail: geral@universalmotors.pt

* References applied only in the UK